

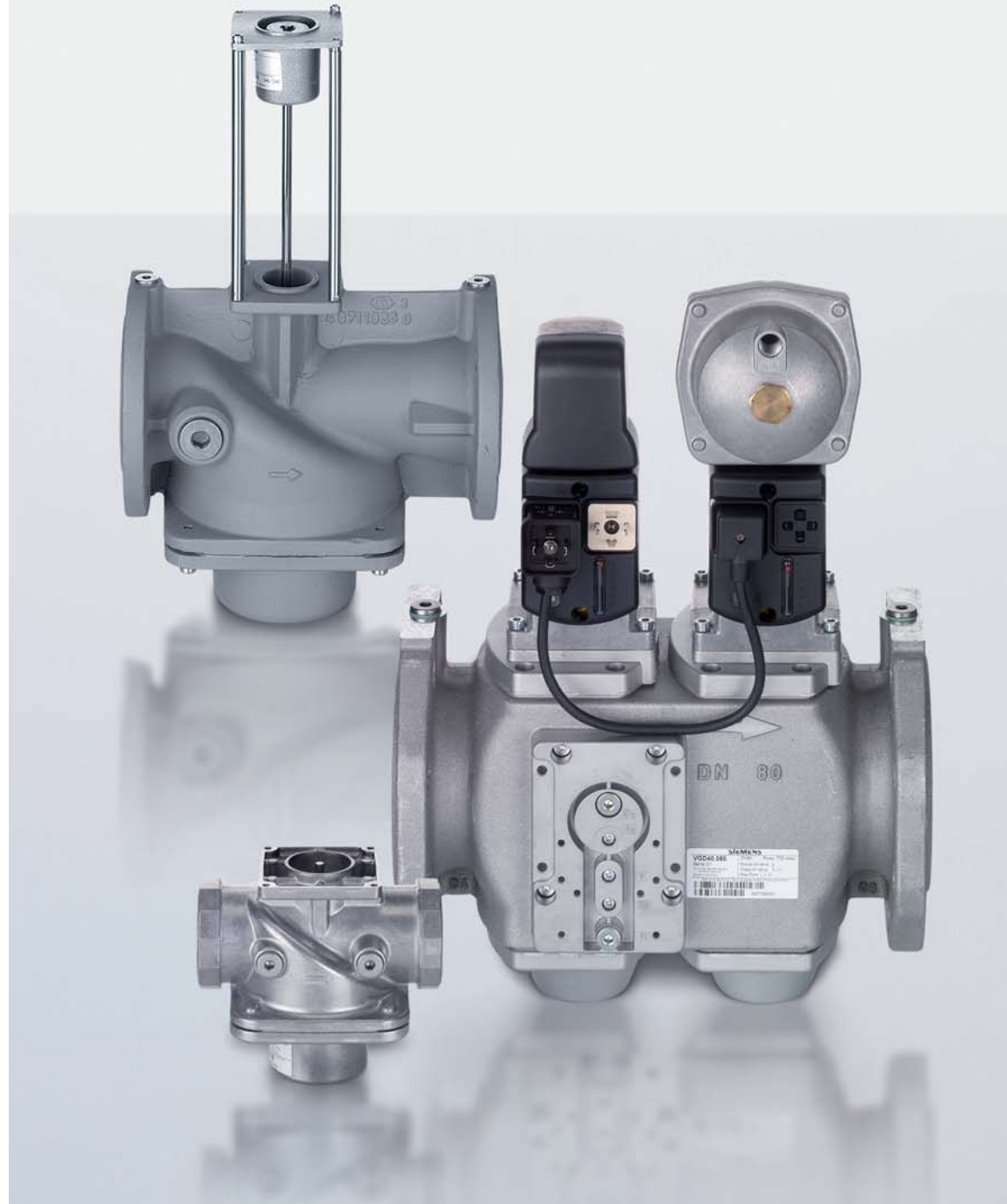

OEM Heat Control Systems

Valves and their actuators

Combinations for every type of application



Answers for industry.

SIEMENS

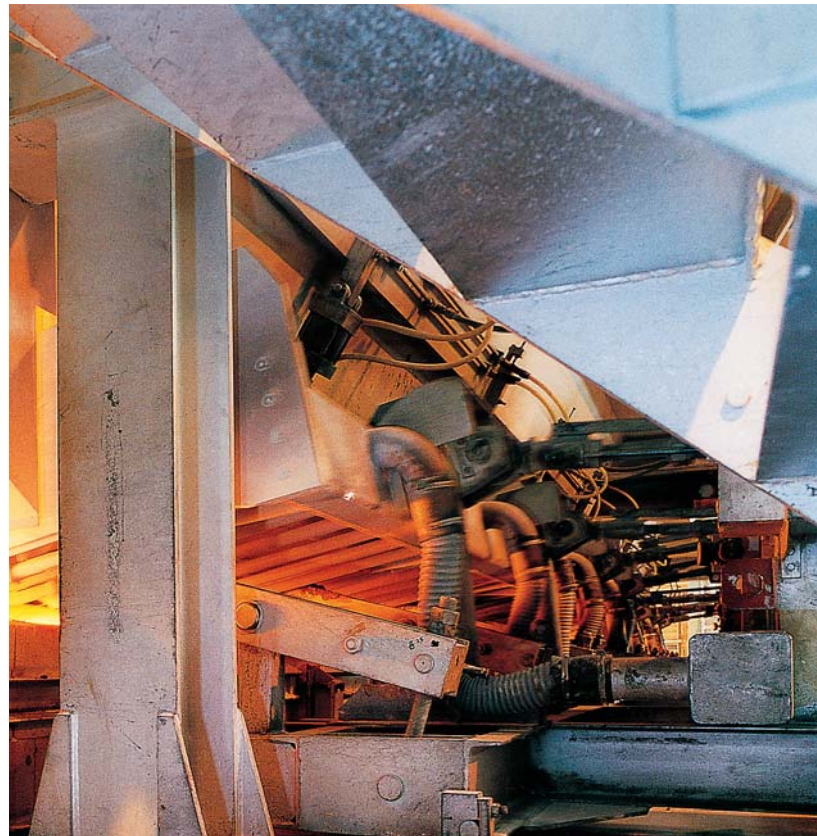

Modular concept based on powerful components

To us, the valve and actuator are two separate components. Due to their features and excellent performance, any of our actuators can be combined with any of our valves. The range of double gas valves includes valves of class A in nominal sizes from 1½" to DN 150, covering typical burner capacities from 300 kW to 30 MW.

The modular design of valve and actuator ensures flexibility in terms of mounting, on site service and stock holding. The actuators can be fitted to gas trains installed on the left or right hand side. Even in the case of service, there is no need to worry about operating conditions since only one type of actuator is required – independent of the type of valve.

The actuators can be replaced while the system is under pressure, without having to remove the valve.



Extremely versatile and cost-saving

■ Future-oriented burner management from Siemens

In addition to products for floor-standing and wall-hung boilers, Siemens develops, produces and supplies components for use with forced draft standard burners and industrial burners.

The comprehensive range of products includes burner controls, actuators, sensors and flame detectors, control systems, valves, test equipment and integrated system solutions.

These products and systems enable us to offer optimum solutions for our customers' market segments. They include single- and multi-family houses (residential buildings), commercial buildings and complex firing systems for industrial processes.

■ Extensive coverage of processes

Thanks to the modular concept, the VG/SKP products meet the requirements of a broad range of applications in the commercial and industrial sectors. Only a small number of versions are needed to cover all kinds of operating conditions, thus facilitating on site service work and stock holding.

■ Siemens Solution Partner program

Our Solution Partners deliver all elements and services required for operating closed thermal process plants – from engineering and measures required for plant optimization to gas control systems and switchboard construction including comprehensive services.

The Solution Partners for Industrial Combustion are well trained and have the latest information about Siemens products. We maintain a continuous dialog with these partners, aimed at meeting current market needs.

Highlights

- Modular concept
- Broad application area
- Service-friendly
- Proven Solution Partner program
- Worldwide approvals

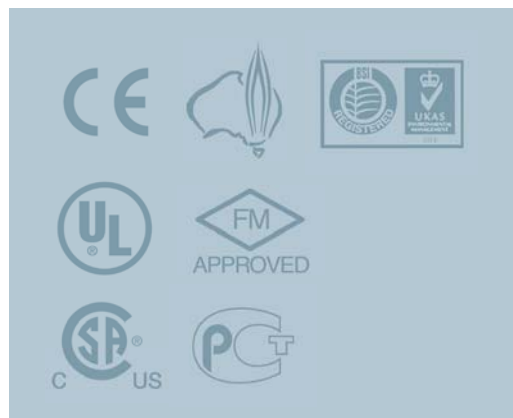

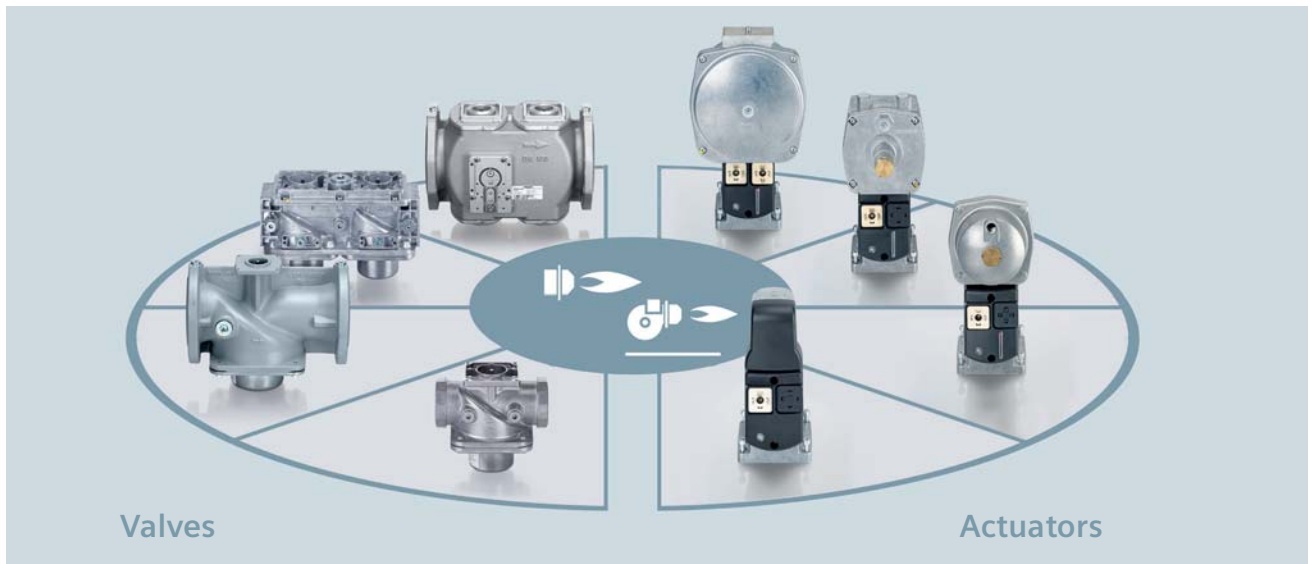

Perfect modular concept

Siemens gas valves and actuators of the VG/SKP line are based on more than 30 years of experience.

More than one million Siemens gas valves are installed in the field, operating on a host of different applications – be it in the commercial heating market or in industrial firing systems.

Over the years, the modular concept of the VG/SKP line has been continually improved with regard to functionality, robustness and user friendliness – and is still unmatched in the marketplace.



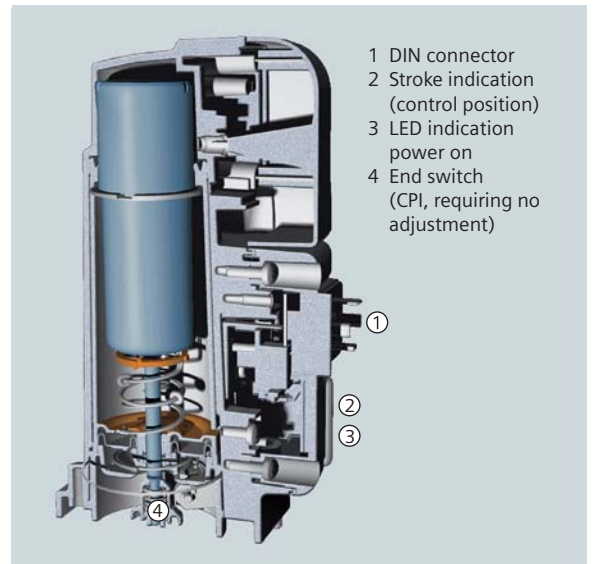
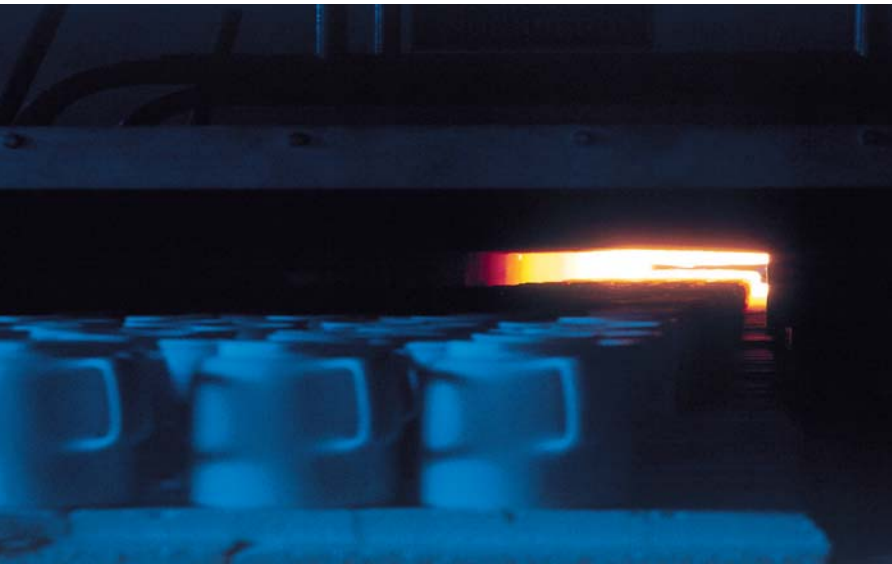

SKP valve actuators – simply exemplary

■ Extensive scope of functions

In terms of functions, the SKP are available in four different versions: As basic open/closed actuators, as open/closed actuators with constant pressure governor, with differential pressure governor, or with pressure ratio controller. Each actuator is compatible with all nominal valve sizes and can be fitted to the valve in various positions.

The settings are made independently of the nominal size of valve.

All operating elements are located on the same side. This simplifies operation and improves service friendliness. The actuators feature an LED to indicate power on. All types of actuator with control function feature stroke indication.

■ Straightforward operation and mounting

The actuator's current position and control behavior can be viewed at a glance. Also, the actuator can be equipped with an optional integrated end switch.

Our smart plug-and-play solution is extremely easy to mount and service-friendly: The actuator can simply be connected via a DIN connector. End switches (CPI) are factory set. Together with the captive screws, mounting time is thus minimized: Simply fit it, connect it and turn power on.

During commissioning or when service work is carried out, the burner pressure can be checked via a test point directly on the SKP's pressure governor.

Highlights

- Modular concept/flexibility
- Straightforward operation
- For high gas pressures

SKP15



Open/closed

SKP25



Open/closed constant pressure governor

SKP55



Open/closed differential pressure governor

SKP75



Open/closed pressure ratio controller

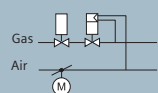
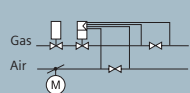
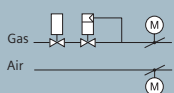
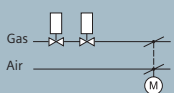
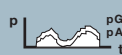



VGD double gas valves – extremely robust

■ About precision and other benefits

The VGD gas valves from Siemens make full use of the advantages offered by the double valve design: Compact and low weight. They afford high inlet pressures of up to 1,000 mbar and excel in high flow rates.

Any valve of the VGD line can be combined with any of our actuators. And since we also attach great importance to versatile accessories, the universal mounting plate enables any valve of the VGD40 line to be equipped with pressure switches and valve proving systems of all major suppliers.

The mounting plates are interchangeable, allowing them to be matched to gas trains arranged on the left or right hand side.

Space-saving and powerful: compact design, high valve operating forces and unique double seat design of the VGD40 (illustration at right).

■ Sophisticated technology for more safety

Safety is of prime importance when it comes to gas applications. While VGD20 are of single-seat design, all double valves of the VGD40 line use a unique, patented double-seat design.

This special design ensures that both valve seats are closed by two individual springs producing independent forces of more than 100 N. The resultant automatic compensation of distance offers more safety.

Highlights

- Nominal sizes from DN 40 to DN 150 or 1 ½" to 2"
- High inlet pressure ranges
- High flow rate thanks to patented double seat design
- Market-specific versions (e.g. U.S. models)

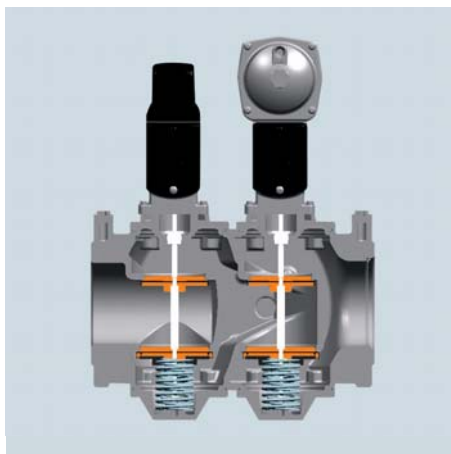
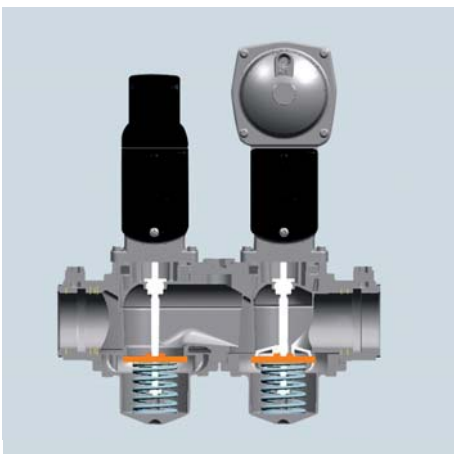

Type of valve

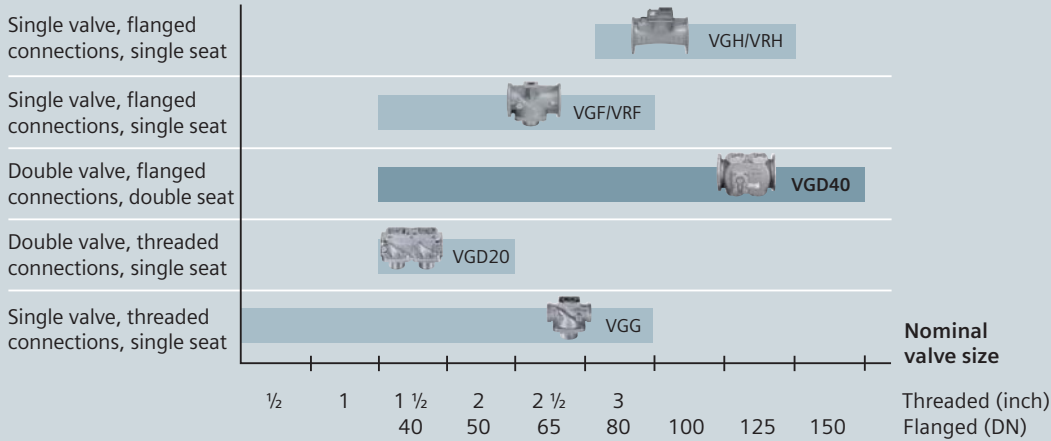

Extensive choice of applications

Extremely versatile

The separation of gas valve and electrohydraulic actuator from the design point of view makes it possible to build robust and flexible gas trains with only a small number of product versions. Powerful closing springs ensure extremely tight valve seats, making the valves less susceptible to small particles in the gas flow. In certain cases, fine filters on the gas valve's inlet side can be dispensed with.

For use on industrial applications, SKP electro hydraulic actuators offer another decisive advantage: 100 % on time, if required, and an unlimited number of switching cycles.

Smart technical design

The damped opening characteristic of the SKP actuator ensures smooth and reliable burner startup. Adjustment of the SKP is straightforward and always the same, irrespective of the nominal size of valve.

Overall efficiency is increased due to low power consumption, thus helping to cut plant operating costs.

Highlights

- Small number of versions
- Very low power consumption
- Robust and dirt-resistant
- Straightforward operation and adjustment

Mains pressure	Typical application VGD40/SKP	Pi static VGD40	Pi operation VGD40	Po burner pressure
1...4 bar		1,500 mbar	...700 mbar all nominal sizes	Depending on SKP model/ setpoint spring 0...700 mbar Depending on mains pressure, certain high-pressure components may not be needed (shown in orange). Components shown in grey are optional.
0.7...1 bar		1,500 mbar	...700 mbar DN 65...150	
0.7...1 bar		1,500 mbar	...1,000 mbar DN 40, DN 50	
...0.7 bar		1,500 mbar	...700 mbar all nominal sizes	



GASP and other accessories

■ Valve sizing software

To simplify planning and engineering, Siemens developed a special gas valve sizing program (GASP).

GASP is used to size gas valves and to determine the presetting of the gas-air ratio with the SKP75.

■ Solenoid valves

Siemens solenoid valves of the VGS line are used as pilot valves in connection with VG/SKP. On industrial combustion plants, they serve as fast-opening main gas valves up to 1". Certain types of VGS valves feature volume adjustment.

■ Pressure switches







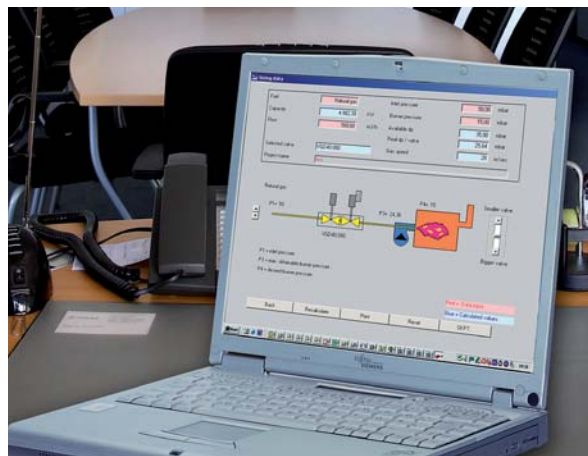

















Siemens gas and air pressure switches of the QPL line monitor mains pressure, maximum burner pressure, or are used in connection with a gas valve proving system. Owing to their design, the pressure switches can be fitted to Siemens valves in a number of ways.

Highlights



- Simplified valve sizing
- Solenoid valve with flow adjustment for use as a pilot valve
- Pressure switch for air and gas pressures on gas trains



Always the right valve available

			Suited for bio/recycling gas	Connections	Nominal size	Permissible inlet pressure	Design	Suited for use with SKP
Field of use								
Type of valve		VGD20			1 1/2" ... 2"	600 mbar		■
		VGD40	■ ¹⁾		DN 40... DN 150	700...1,000 mbar		■
		VGG			1/2" ... 3"	...1,200 mbar		■
		VGF			DN 40... DN 80	600 mbar		■
		VRF	■		DN 40... DN 80	600 mbar		■
		VGH			DN 80... DN 125	300 mbar		■
		VRH	■		DN 80... DN 125	300 mbar		■
		VGS			3/8" ... 1"	750...1,000 mbar		

Legend:

-  Flange
-  Internally threaded
-  Seat

-  Double seat
-  Flap

1) Free of non-ferrous metals up to 0.1 % H₂S

Siemens Switzerland Ltd
Building Technologies Division
International Headquarters
OEM Heat Control Systems
Gubelstrasse 22
CH-6301 Zug
Tel +41 41 724 41 25
Fax +41 41 724 51 30

Siemens Building Technologies
HVAC Products GmbH
OEM Heat Control Systems
Berliner Ring 23
D-76437 Rastatt
Tel +49 7222 598 279
Fax +49 7222 598 269

The information in this document contains general descriptions of technical options available, which do not always have to be present in individual cases. The required features should therefore be specified in each individual case at the time of closing the contract.

Subject to change • Order no. R-1000160902-en
© Siemens Switzerland Ltd • Printed in Germany